

KIT/NVR301-08LS2-W/6*IPC2122LR3-F40W-E



Key Features

NVR301-08LS2-W

- Embedded WiFi Module with high-performance and high stability
- Support CCMP encryption and WPA2-PSK authentication, Support IP cameras with WiFi in access
- Support Ultra 265/H.265/H.264 video formats
- 8-channel input
- Third-party IP cameras supported with ONVIF conformance: Profile S, Profile G, Profile T
- Support 1-ch HDMI, 1-ch VGA
- HDMI and VGA synchronous outputs provided
- Up to 5MP resolution recording
- 1 SATA HDD, Up to 6TB for each HDD
- Support cloud upgrade

IPC2122LR3-F40W-E

- Day/night functionality
- Smart IR , up to 30 m (98 ft) IR distance
- Optical glass window with higher light transmittance
- IR anti-reflection window to increase the infrared transmittance
- 2D/3D DNR (Digital Noise Reduction)
- Ultra 265,H.265, H.264
- Dual streams
- ONVIF Conformance
- Wide temperature range:-30°C ~ +60°C (-22°F ~ 140°F)
- Wide voltage range of ±25%
- IP67

Specifications

Model	NVR301-08LS2-W
Video/Audio Input	
IP Video Input	8-ch
Network	
Incoming Bandwidth	40Mbps
Outgoing Bandwidth	40Mbps
Remote Users	128
Protocols	P2P, UPnP, NTP, DHCP, PPPoE
Video/Audio Output	
HDMI/VGA Output	HDMI: 1920x1080p /60Hz, 1920x1080p /50Hz, 1600x1200 /60Hz, 1280x1024 /60Hz, 1280x720 /60Hz, 1024x768 /60Hz VGA: 1920x1080p /60Hz, 1920x1080p /50Hz, 1600x1200 /60Hz, 1280x1024 /60Hz, 1280x720 /60Hz, 1024x768 /60Hz
Recording Resolution	5MP/4MP/3MP/1080p/960p/720p/D1/2CIF/CIF
Audio Output	1-ch, RCA
Synchronous Playback	8-ch
Corridor Mode Screen	3/4
Decoding	
Decoding format	Ultra 265/H.265/H.264
Live view/ Playback	5MP/4MP/3MP/1080p/960p/720p/D1/2CIF/CIF
Capability	1 x 5MP@30, 2 x 4MP@25, 2 x 3MP@30,4 x 1080P@25, 8 x 960P@25, 8 x 720P@30
Hard Disk	
SATA	1 SATA interface

Capacity	Up to 6TB for each HDD				
External Interface					
Network Interface	1 RJ45 10M/100M self-adaptive Ethernet Interface				
USB Interface	Rear panel: 2 x USB2.0				
Wi-Fi					
Frequency	2.4GHz				
Transmission Rate	150Mbps				
Wireless Standards	IEEE 802.11b/g/n				
Wireless Range	280m(open environment)				
General					
Power Supply	12V DC Power Consumption: ≤ 9 W(without HDD)				
Working Environment	-10°C ~ + 55°C (+14°F ~ +131°F), Humidity ≤ 90% RH(non-condensing)				
Dimensions(W×D×H)	205mm × 205mm × 46mm (8.1" ×8.1"×1.8")				
Weight (without HDD)	≤0.58Kg(1.28lb)				
Model	IPC2122LR3-F40W-E				
Sensor	1/2.9", 2.0 megapixel, progressive scan, CMOS				
Lens	4.0mm@F2.0				
DORI Distance	Lens	Detect(m)	Observe(m)	Recognize(m)	Identify(m)
	4mm	64.3	25.7	12.9	6.4
Angle of view(H)	82.0°				
Angle of View (V)	41.4°				
Angle of View (O)	100.9°				
Shutter	Auto/Manual, 1~1/100000 s				
Minimum Illumination	Colour: 0.02 Lux (F2.0 AGC ON) 0 Lux with IR on				
Day/Night	IR-cut filter with auto switch (ICR)				
Digital noise reduction	2D/3D DNR				
S/N	>52dB				
IR Range	Up to 30m (98 ft) IR range				
Defog	Digital Defog				
WDR	DWDR				
Video					
Video Compression	Ultra 265, H.265, H.264				
H.264 code profile	Baseline profile, Main Profile				
Frame Rate	Main Stream:2MP (1920×1080): Max. 20 fps; Sub Stream: 720P (1280×720): Max. 20 fps;				
HLC	Supported				
BLC	Supported				
OSD	Up to 4 OSDs				
Privacy Mask	Up to 4 areas				
ROI	Up to 2 areas				
Motion Detection	Up to 4 areas				
Network					
Protocols	IPv4, IGMP, ICMP, TCP, UDP, DHCP, RTP, RTSP, RTCP, DNS, DDNS, NTP, UPnP, HTTP				

Compatible Integration	ONVIF (Profile S, Profile T), API
Wi-Fi	
Wireless Standards	IEEE802.11b/g/n
Frequency Range	2.4 GHz ~ 2.4835 GHz
Channel Bandwidth	20 MHz Support
Modulation Mode	802.11b: CCK, QPSK, BPSK 802.11g/n: OFDM/HT
Security	64/128-bit WEP, WPA-PSK/WPA2-PSK
Transmit Power	802.11b: 17±1.5dBm @11Mbps 802.11g: 14±1.5dBm @ 54Mbps 802.11n: 12.5±1.5dBm @150Mbps
Receive Sensitivity	802.11b: -90dBm @11Mbps (Typical) 802.11g: -75dBm @54Mbps (Typical) 802.11n: -74dBm @150Mbps (Typical)
Transmission Rate	802.11b: 11Mbps 802.11g: 54Mbps 802.11n: up to 150Mbps
Interface	
Network	1 RJ45 10M/100M Base-TX Ethernet
General	
Power	DC 12V±25%
	Power consumption: Max 4 W
Dimensions (L × W × H)	161.1 × 62.5 × 62.7mm (6.3" × 2.5" × 2.5")
Weight	0.25 kg (0.55 lb)
Working Environment	-30°C ~ +60°C (-22°F ~ 140°F), Humidity: ≤95% RH(non-condensing)
Ingress Protection	IP67
Reset Button	Supported

Dimensions

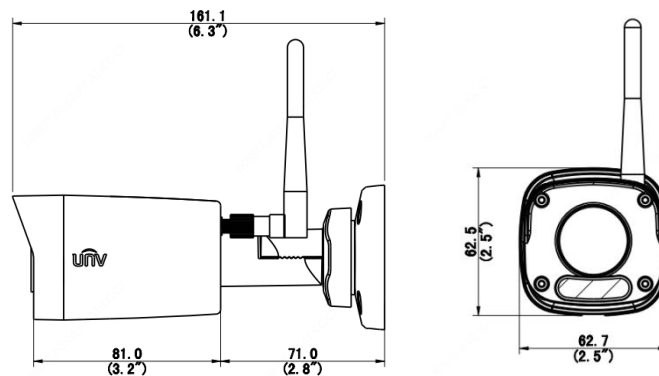

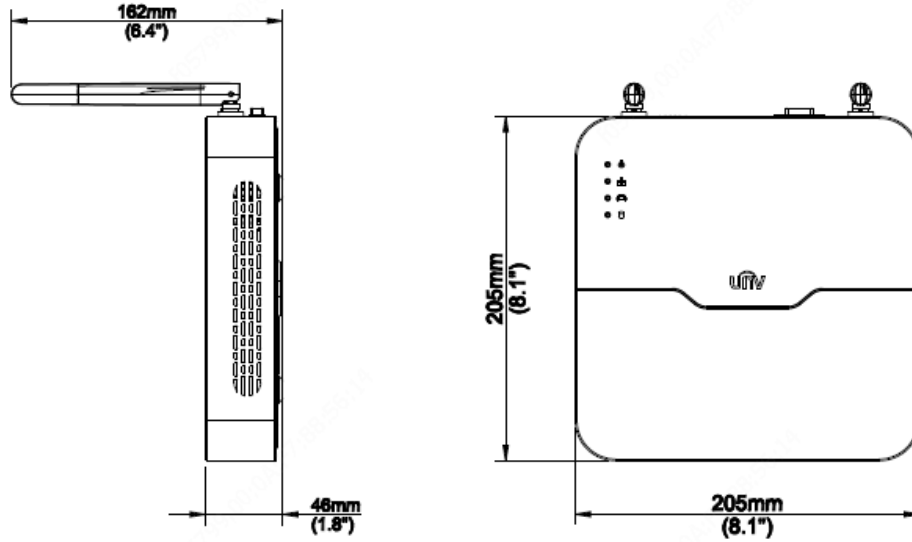

Rear Panel

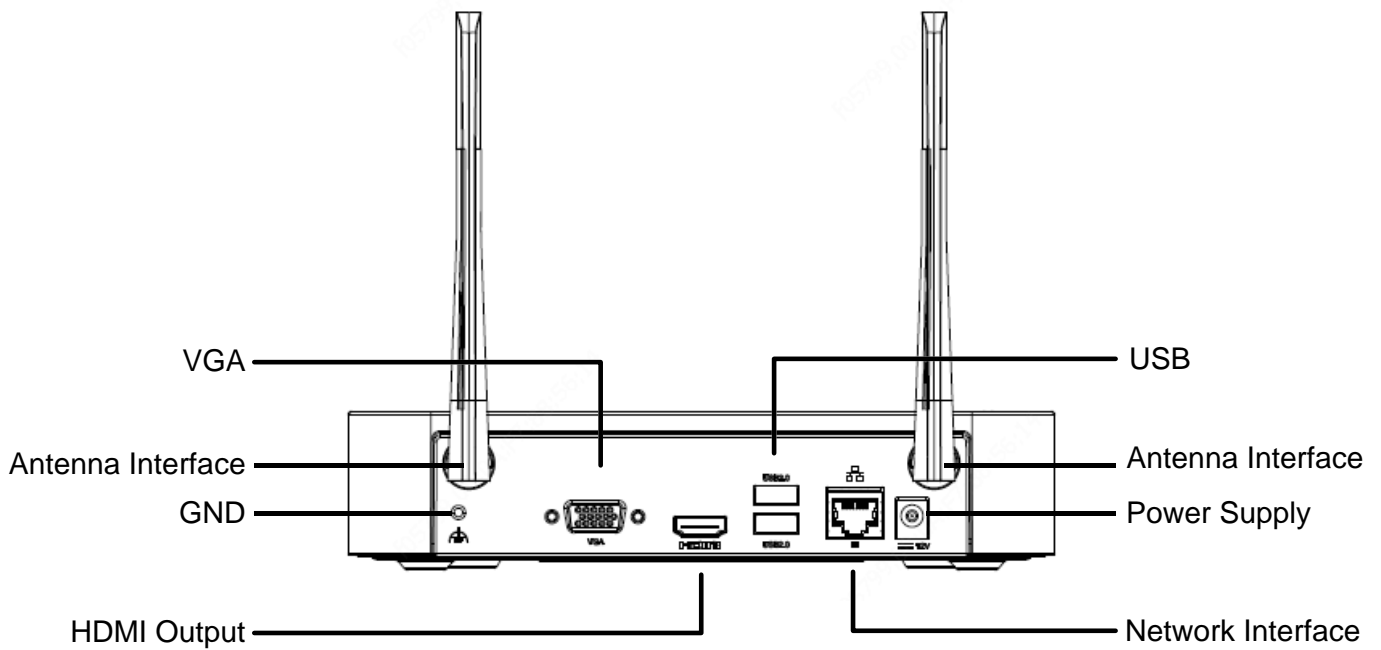

Zhejiang Uniview Technologies Co., Ltd.

Building No.10, Wanlun Science Park, Jiangling Road 88, Binjiang District, Hangzhou, Zhejiang, China

Email: overseasbusiness@uniview.com; globalsupport@uniview.com

<http://www.uniview.com>

©2019-2020 Zhejiang Uniview Technologies Co., Ltd. All rights reserved.

* Product specifications and availability are subject to change without notice.